



Date: September 04/05

Organization: FPT / ACAEDM

Shooting Range: Lugar da Espinheira, Cabanelas, 4730-000 Vila Verde [41° 35' 45" N - 8° 30' 21" W](#)

Match Level: III





OPEN DE PORTUGAL 2010



RULES: Practical Shooting Handbook, Latest Edition

COURSE DESIGNER: R.O. José Gonçalves

START POSITION: Standing with toes touching marks, palms of both hands against wall. Gun placed unloaded on shelf, muzzle downrange.

START CONDITION: Handgun unloaded with magazine inserted

STAGE N.º 01 – (Long Course)

STAGE PROCEDURE: At the start signal, pick up the gun from the self and engage targets as they become available from area A..

SCORING: Comstock, 32 rounds, 160 points

TARGETS: 1 Plate, 15 IPSC Targets, 1 Classic Popper

SCORED HITS: Best 2 per paper. Metal down = 5 points

START-STOP: Audible signal - Last shot

PENALTIES: Per current edition IPSC Rule Book

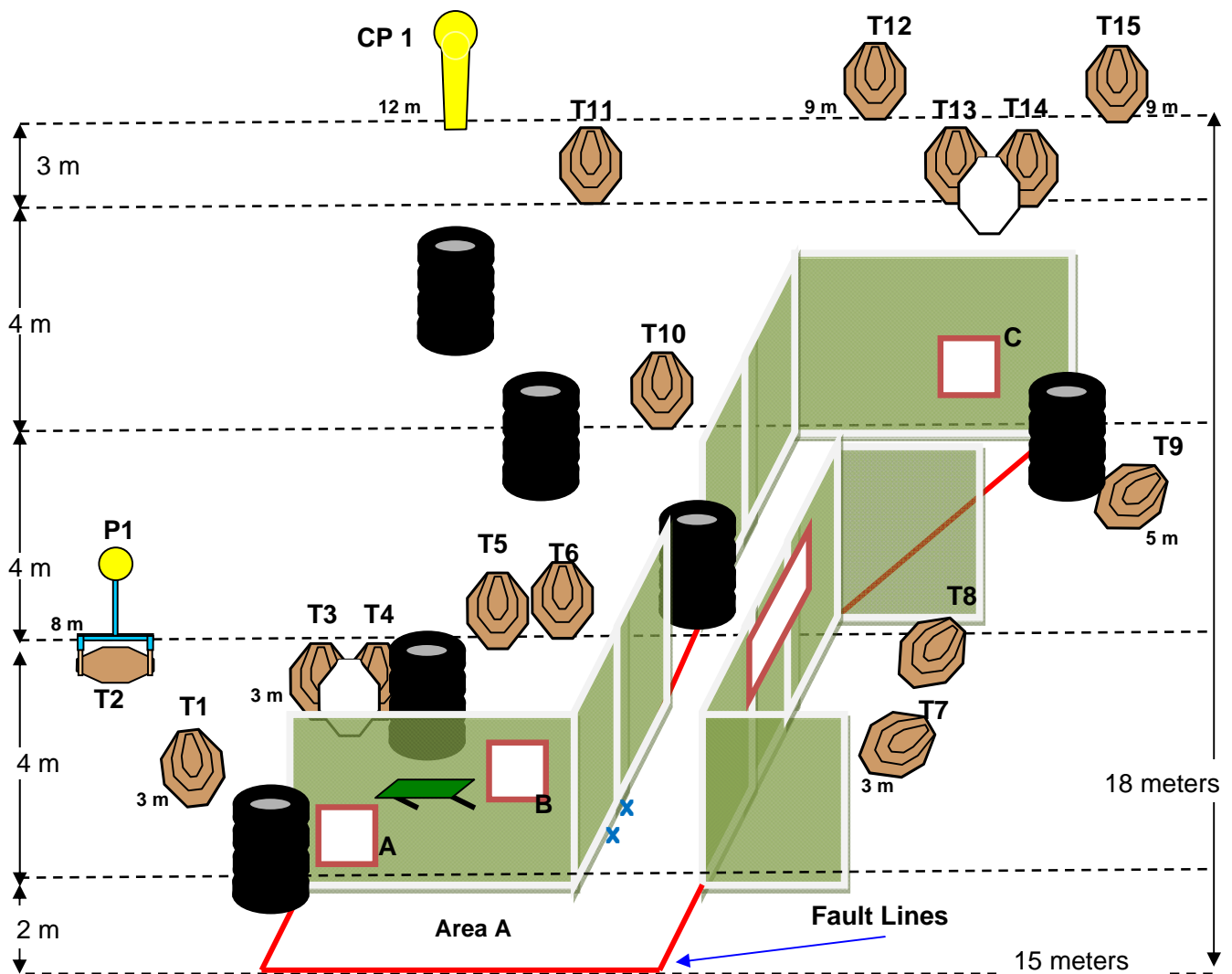

SETUP NOTES:

Windows A and C 0.50 meters and B 1.20 meters of the soil.

RO NOTES:

Arbitration Fees 80,00 €





OPEN DE PORTUGAL 2010



RULES: Practical Shooting Handbook, Latest Edition

COURSE DESIGNER: R.O. José Gonçalves

START POSITION: Standing in XX position, facing down range, with hands touching the panel.

START CONDITION: Handgun in ready condition and holstered

STAGE N.º 02 – (Medium Course)

STAGE PROCEDURE: Upon start signal, draw and engage all targets in any order.

SCORING: Comstock, 16 rounds, 80 points

TARGETS: 8 Classic Targets.

SCORED HITS: Best 2 per paper. Metal down = 5 points

START-STOP: Audible signal - Last shot

PENALTIES: Per current edition IPSC Rule Book

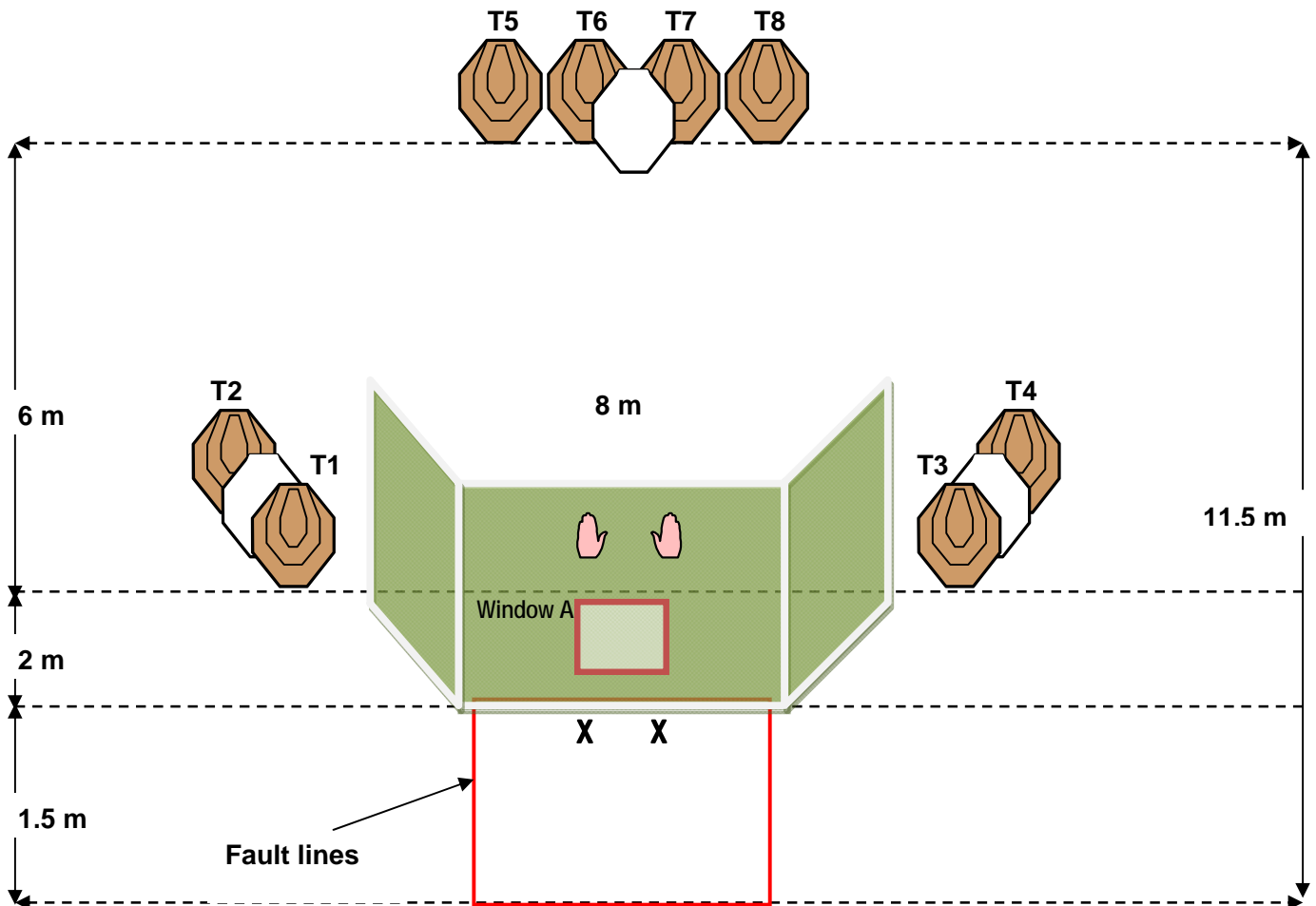

SETUP NOTES:

Window A is 0,50 meters of the soil.

RO NOTES:

Arbitration Fees 80,00 €





OPEN DE PORTUGAL 2010



RULES: Practical Shooting Handbook, Latest Edition

COURSE DESIGNER: R.O. José Gonçalves

START POSITION: Standing inside fault lines, facing down range, hands naturally at sides.

START CONDITION: Handgun in ready condition and holstered.

STAGE N.º 03 – (Short Course)

STAGE PROCEDURE: Upon start signal, draw and from inside fault lines engage all targets.

SCORING: Comstock, 08 rounds, 40 points

TARGETS: 3 IPSC Targets, 1 Mini Popper, 1 Classic Popper.

SCORED HITS: Best 2 per paper. Metal down = 5 points

START-STOP: Audible signal - Last shot

PENALTIES: Per current edition IPSC Rule Book

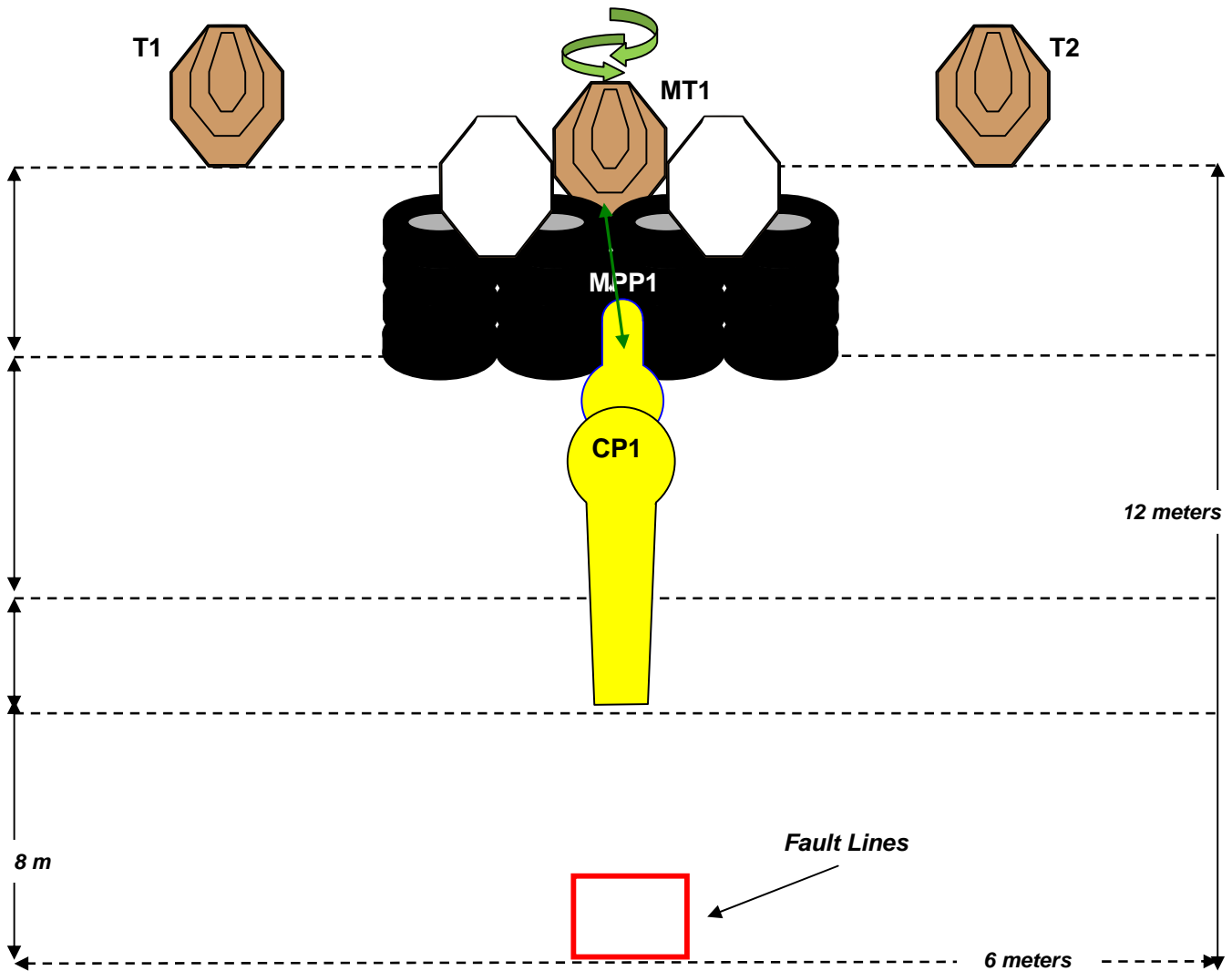

SETUP NOTES:

RO NOTES:

Arbitration Fees 80,00 €



Granitos do Cávado, Lda.



Câmara Municipal Vila Verde



Espingardaria J. & P. Gonçalves, Lda.



Unipessoal, Lda. casas pré-fabricadas • flores • decoração



metalomecânica



MACOMINHO



autocarro bar



OPEN DE PORTUGAL 2010



RULES: Practical Shooting Handbook, Latest Edition

COURSE DESIGNER: R.O. José Gonçalves

START POSITION: Standing seated in the chair holding the plate with the two hands

START CONDITION: Handgun in ready condition on table

STAGE N.º 04 – (Long Course)

STAGE PROCEDURE: Upon start signal, draw and engage all targets when they came visible inside area A..(free style)

SCORING: Comstock, 30 rounds, 150 points

TARGETS: 15 Classic Targets

SCORED HITS: Best 2 per paper. Metal down = 5 points

START-STOP: Audible signal - Last shot

PENALTIES: Per current edition IPSC Rule Book

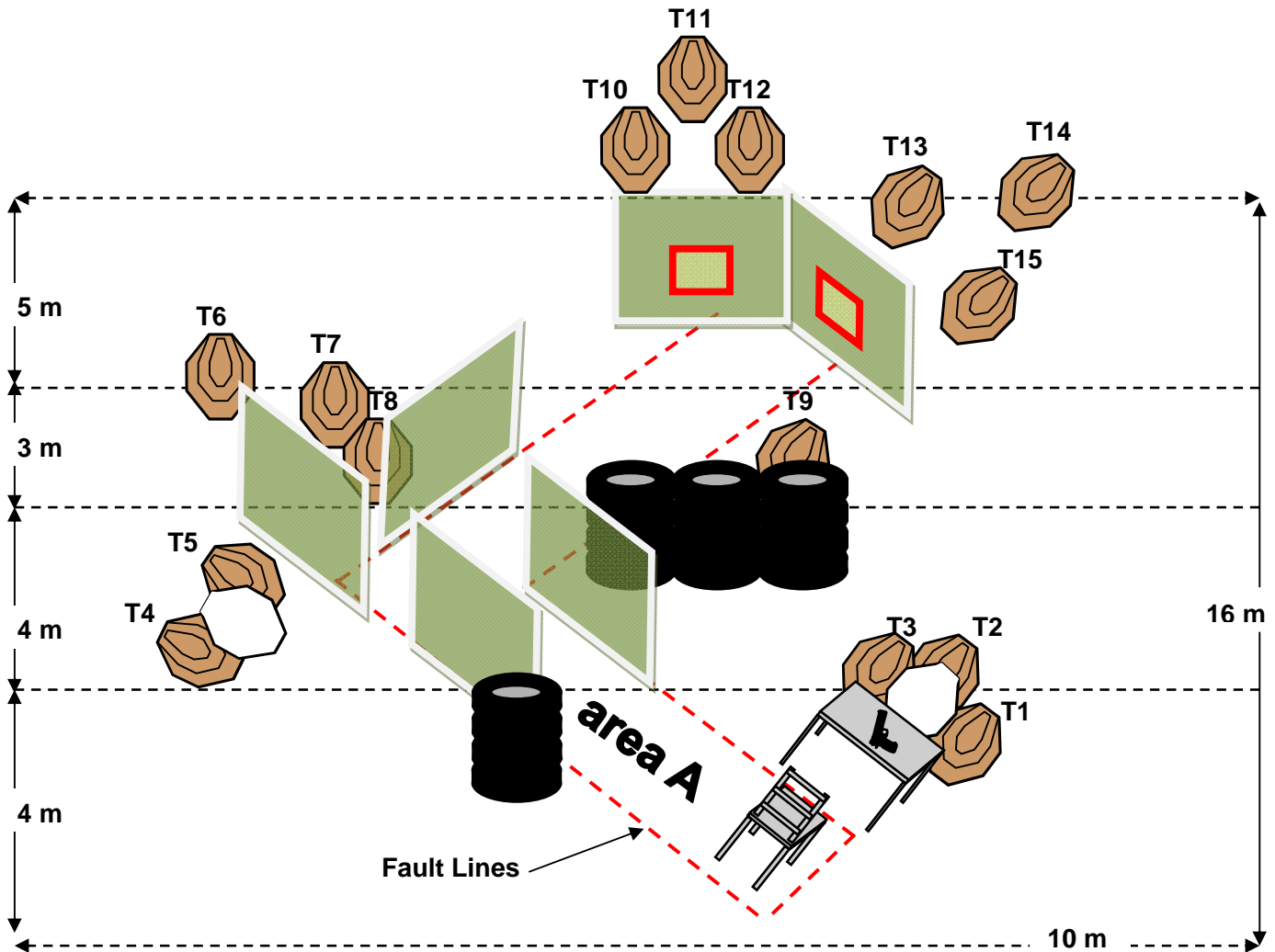

SETUP NOTES:

RO NOTES:

Arbitration Fees 80,00 €





OPEN DE PORTUGAL 2010



RULES: Practical Shooting Handbook, Latest Edition

COURSE DESIGNER: R.O. José Gonçalves

START POSITION: Standing with hands touching marks, palms of both hands against wall, facing down range

START CONDITION: Handgun in ready condition and holstered.

STAGE N.º 05 – (Short Course)

STAGE PROCEDURE: Upon start signal, draw and from within box engage all targets.

SCORING: Comstock, 9 rounds, 45 points

TARGETS: 5 Classic Popper, 2 IPSC Target.

SCORED HITS: Metal down = 5 points

START-STOP: Audible signal - Last shot

PENALTIES: Per current edition IPSC Rule Book

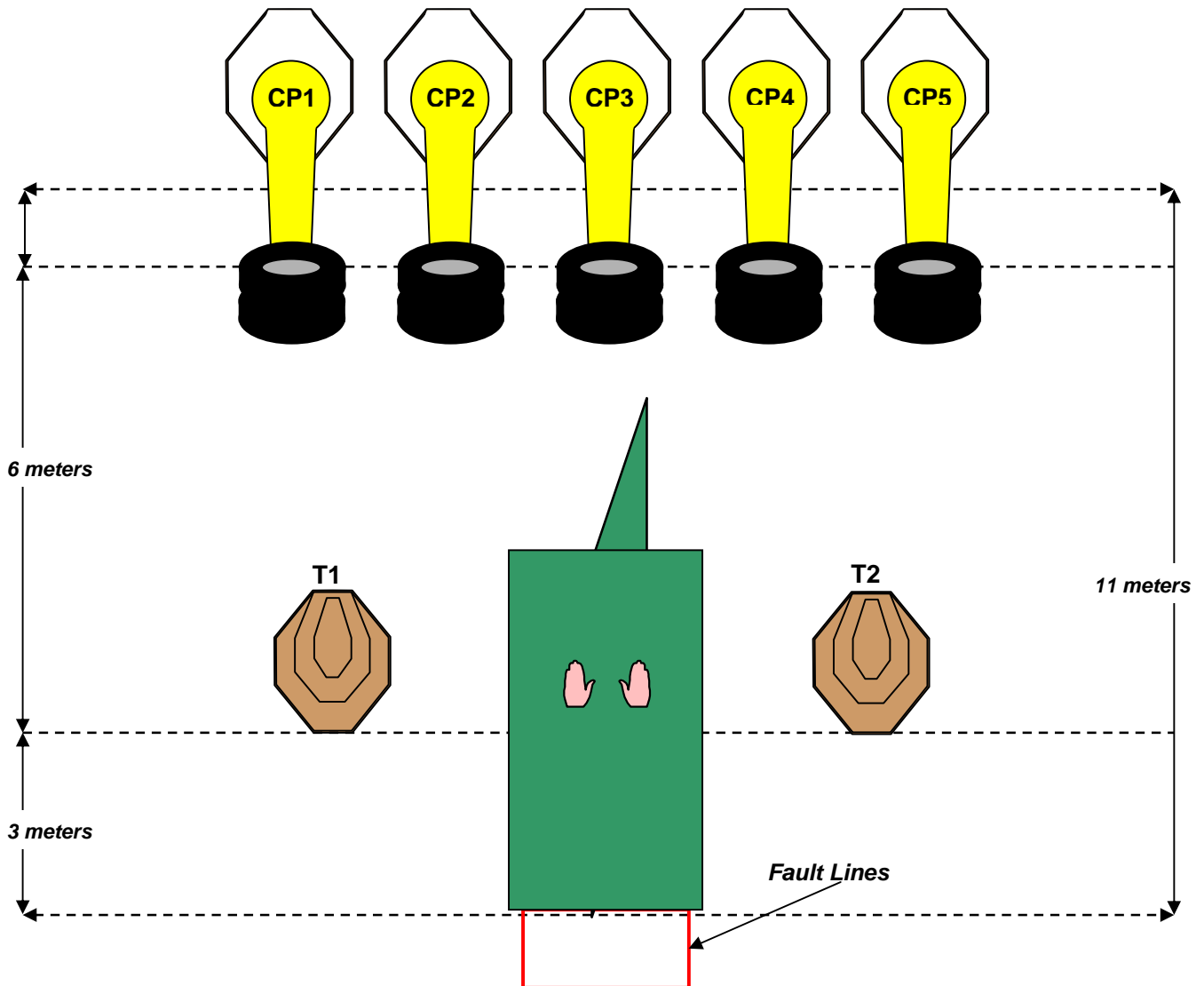

SETUP NOTES:

Fault Lines 1.5x1.0 meters. Between Classic Popper's

RO NOTES:

Arbitration Fees 80,00 €





OPEN DE PORTUGAL 2010



RULES: Practical Shooting Handbook, Latest Edition

COURSE DESIGNER: R.O. José Gonçalves

START POSITION: Standing with toes touching marks, facing down range, hands naturally at sides.

START CONDITION: Handgun in ready condition and holstered.

STAGE N.º 06 – (Medium Course)

STAGE PROCEDURE: Upon start signal, draw and engage all targets in any order (free style).

SCORING: Comstock, 15 rounds, 75 points

TARGETS: 1 Plate, 7 IPSC Targets.

SCORED HITS: Best 2 per paper

START-STOP: Audible signal - Last shot

PENALTIES: Per current edition IPSC Rule Book

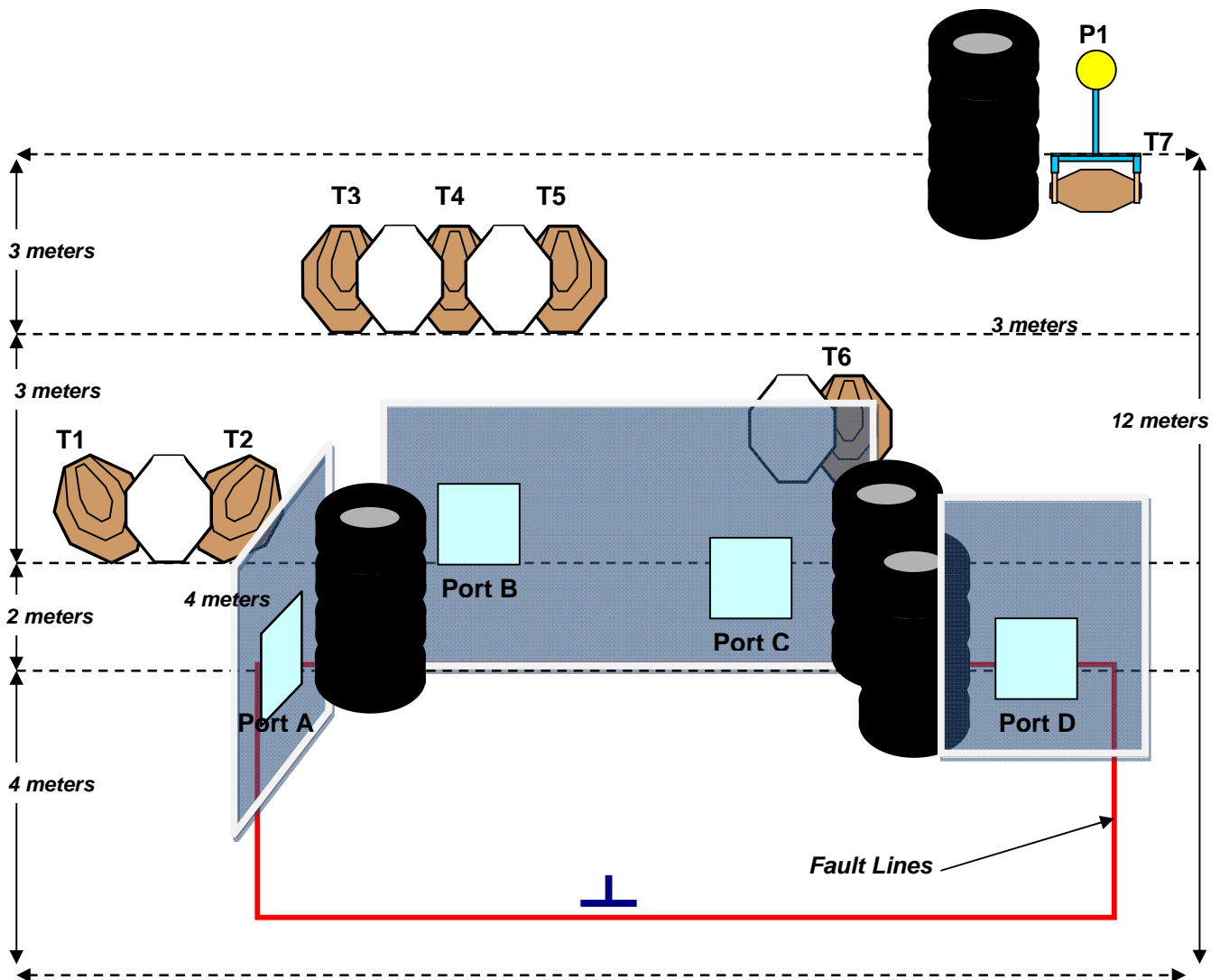

SETUP NOTES:

Barricades windows ports A, C and D 0.50 meters of the soil and port B 0.70 meters. Mini Pepper Popper and Plate distances 8 meters.

RO NOTES:

Arbitration Fees 80,00 €





OPEN DE PORTUGAL 2010



RULES: Practical Shooting Handbook, Latest Edition

COURSE DESIGNER: R.O. José Gonçalves

START POSITION: Standing with toes touching XX marks, facing down range, hands naturally at sides

START CONDITION: Handgun in ready condition and holstered.

STAGE N.º 07 – (Long Course)

STAGE PROCEDURE: Upon start signal, draw and from inside fault lines engage all targets, when they come visible.

SCORING: Comstock, 28 rounds, 140 points

TARGETS: 2 Plate, 13 IPSC Targets.

SCORED HITS: Best 2 per paper. Metal down = 5 points

START-STOP: Audible signal - Last shot

PENALTIES: Per current edition IPSC Rule Book

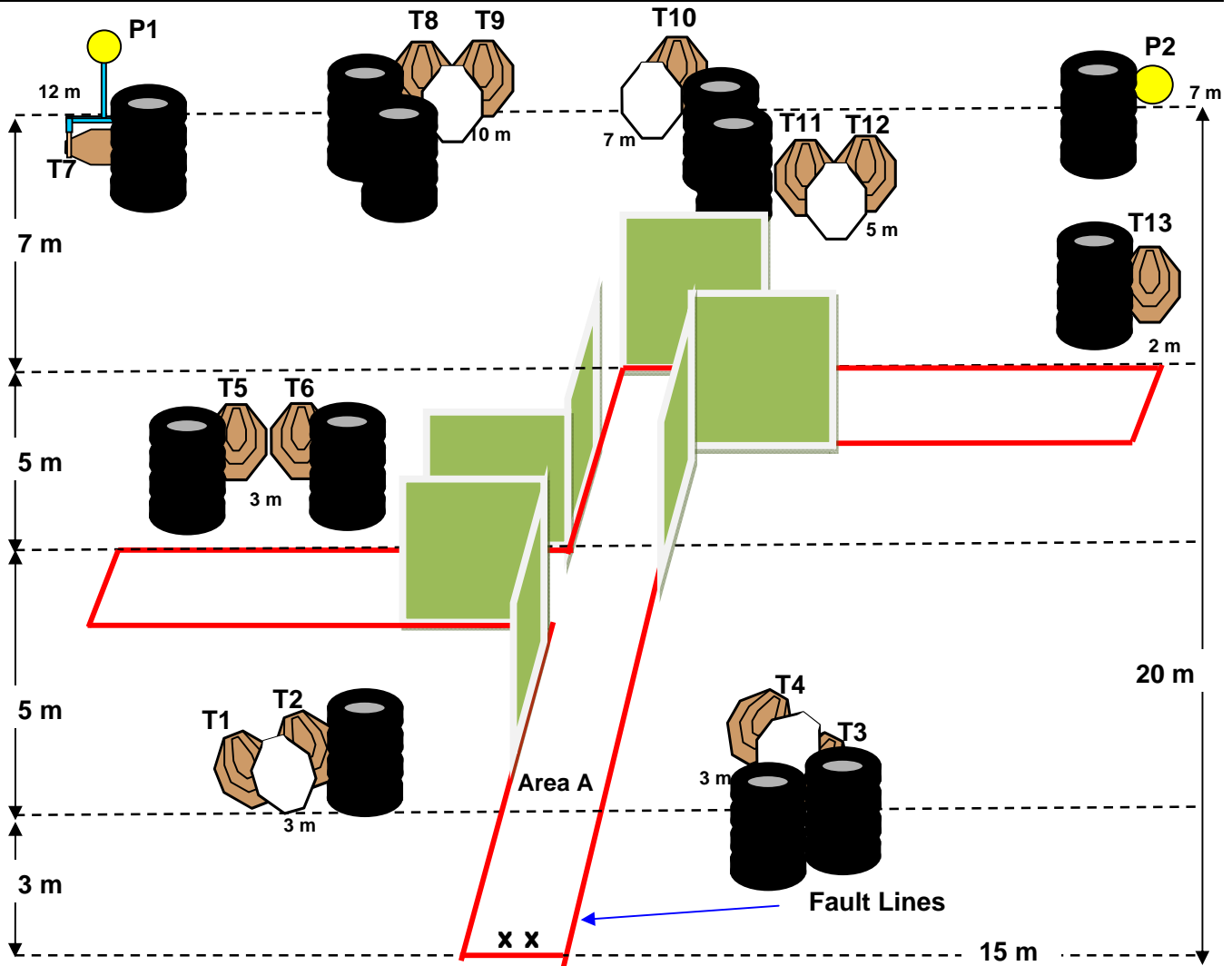

SETUP NOTES:

Windows A/C 0.50 meters and B 1.00 meters of the soil.

RO NOTES:

Arbitration Fees 80,00 €





OPEN DE PORTUGAL 2010



RULES: Practical Shooting Handbook, Latest Edition

COURSE DESIGNER: R.O. José Gonçalves

START POSITION: Standing with toes touching XX marks, facing down range, hands naturally at sides. Firearm on the table.

START CONDITION: Handgun in ready condition on the table

STAGE N.º 08 – (Short Course)

STAGE PROCEDURE: Upon start signal, pick up the gun from the table, and from within box engage all targets.

SCORING: Comstock, 9 rounds, 45 points

TARGETS: 3 Plates, 3 IPSC Targets.

SCORED HITS: Best 2 per paper. Metal down = 5 points

START-STOP: Audible signal - Last shot

PENALTIES: Per current edition IPSC Rule Book

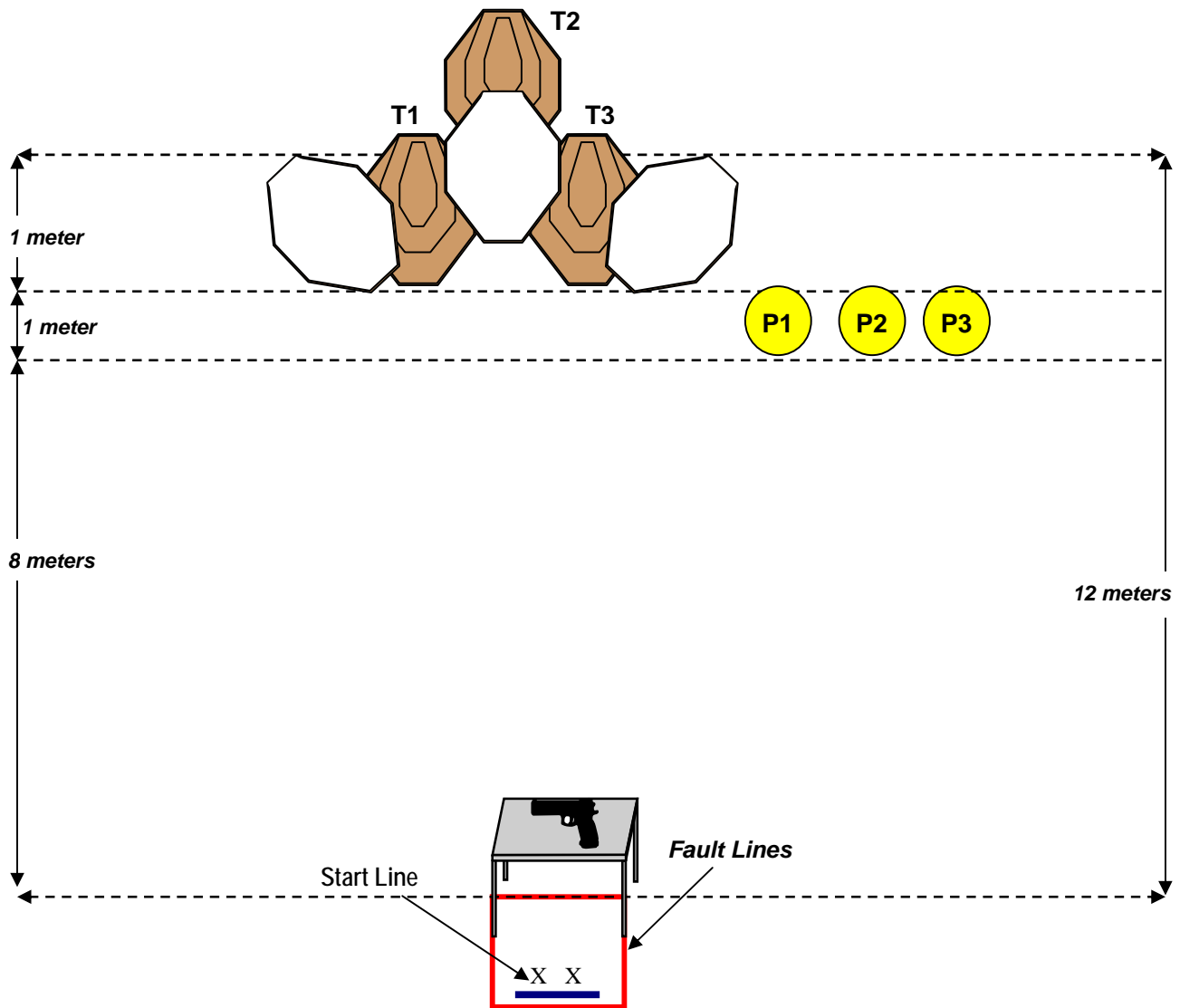

SETUP NOTES:

Fault Lines 1.0x1.0 meters. Plates distance 8 meters.

RO NOTES:

Arbitration Fees 80,00 €





OPEN DE PORTUGAL 2010



RULES: Practical Shooting Handbook, Latest Edition

COURSE DESIGNER: R.O. José Gonçalves

START POSITION: Standing with toes touching XX marks, facing down range, hands naturally at sides

START CONDITION: Handgun in ready condition and holstered.

STAGE N.º 09 – (Medium Course)

STAGE PROCEDURE: Upon start signal, draw and from inside fault lines engage all targets, when they come visible.

SCORING: Comstock, 13 rounds, 55 points

TARGETS: 1 Mini Popper, 6 IPSC Targets.

SCORED HITS: Best 2 per paper. Metal down = 5 points

START-STOP: Audible signal - Last shot

PENALTIES: Per current edition IPSC Rule Book

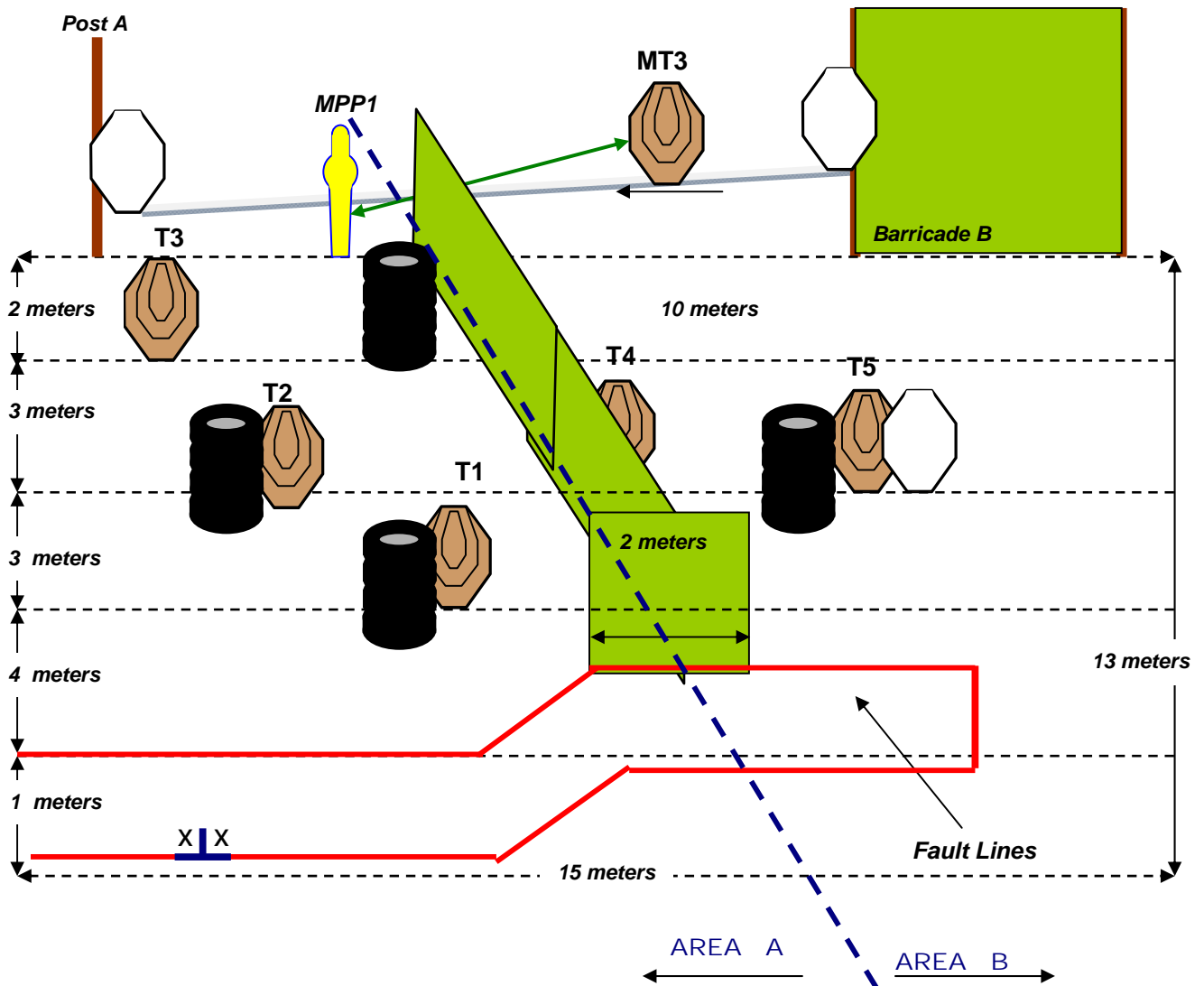

SETUP NOTES:

Distance between post A and barricade B is 3 meters, and Mini Pepper Popper distance is 12 meters.

RO NOTES:

Arbitration Fees 80,00 €





OPEN DE PORTUGAL 2010



RULES: Practical Shooting Handbook, Latest Edition

COURSE DESIGNER: R.O. José Gonçalves

START POSITION: Standing with toes touching marks, hands naturally at sides.

START CONDITION: Handgun in ready condition and holstered.

STAGE N.º 10 – (Short Course)

STAGE PROCEDURE: At the start signal, draw and engage targets as they become available from Area A.

SCORING: Comstock, 09 rounds, 45 points

TARGETS: 1 Plate, 4 IPSC Targets.

SCORED HITS: Best 2 per paper. Metal down = 5 points

START-STOP: Audible signal - Last shot

PENALTIES: Per current edition IPSC Rule Book

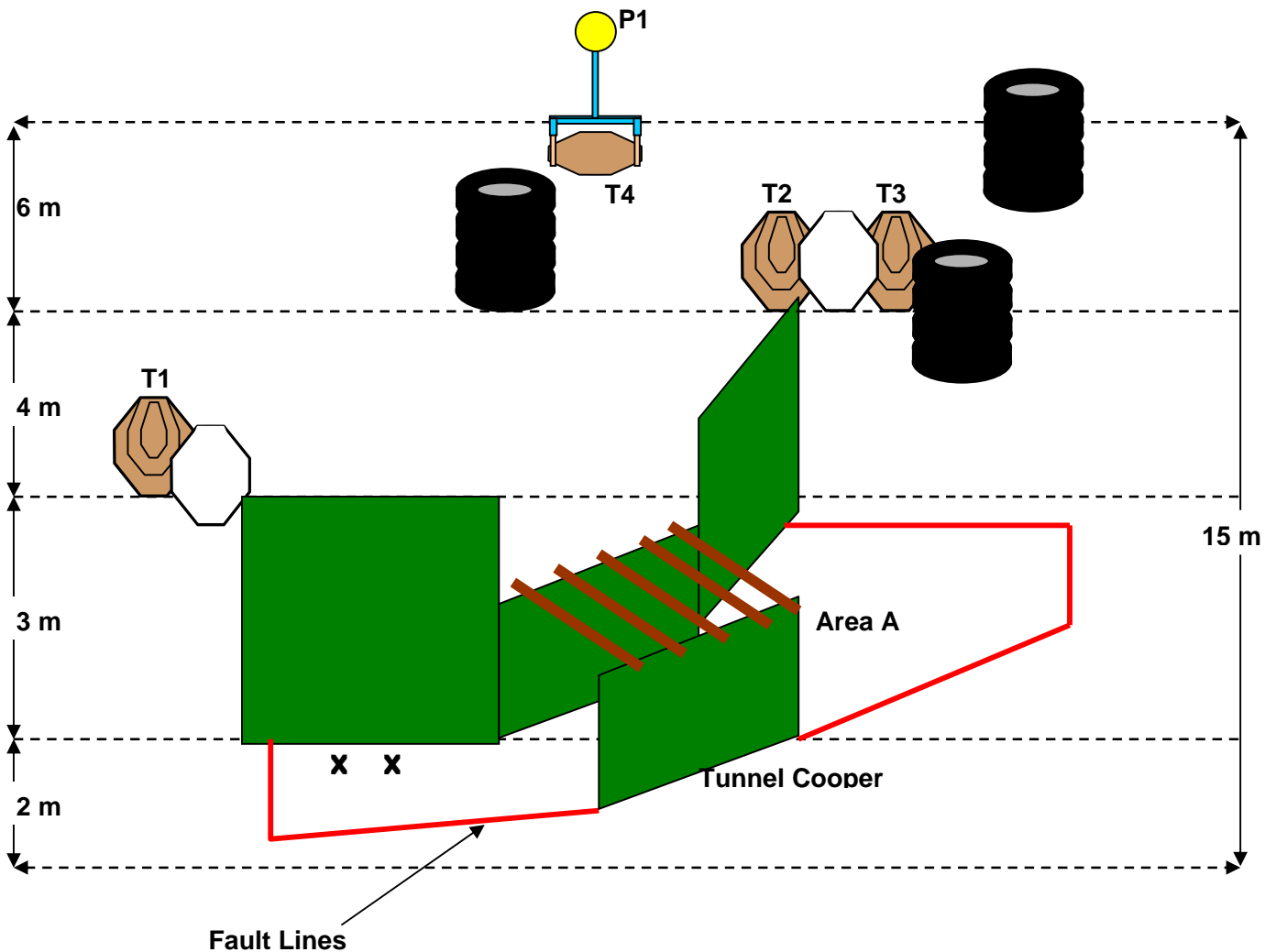

SETUP NOTES:

RO NOTES:

Arbitration Fees 80,00 €





OPEN DE PORTUGAL 2010



RULES: Practical Shooting Handbook, Latest Edition

COURSE DESIGNER: R.O. José Gonçalves

START POSITION: Standing on position A, facing down range, with knees in the soil and hands in the head.

START CONDITON: Handgun unloaded on the position A or B.

STAGE N.º 11 – (Medium Course)

STAGE PROCEDURE: Upon start signal, pick up the gun from positions A or B and engage all targets in any order

SCORING: Comstock, 16 rounds, 80 points

TARGETS: 7 IPSC Targets, 1 Mini Popper, 1 Plate.

SCORED HITS: Best 2 per paper. Metal down = 5 points

START-STOP: Audible signal - Last shot

PENALTIES: Per current edition IPSC Rule Book

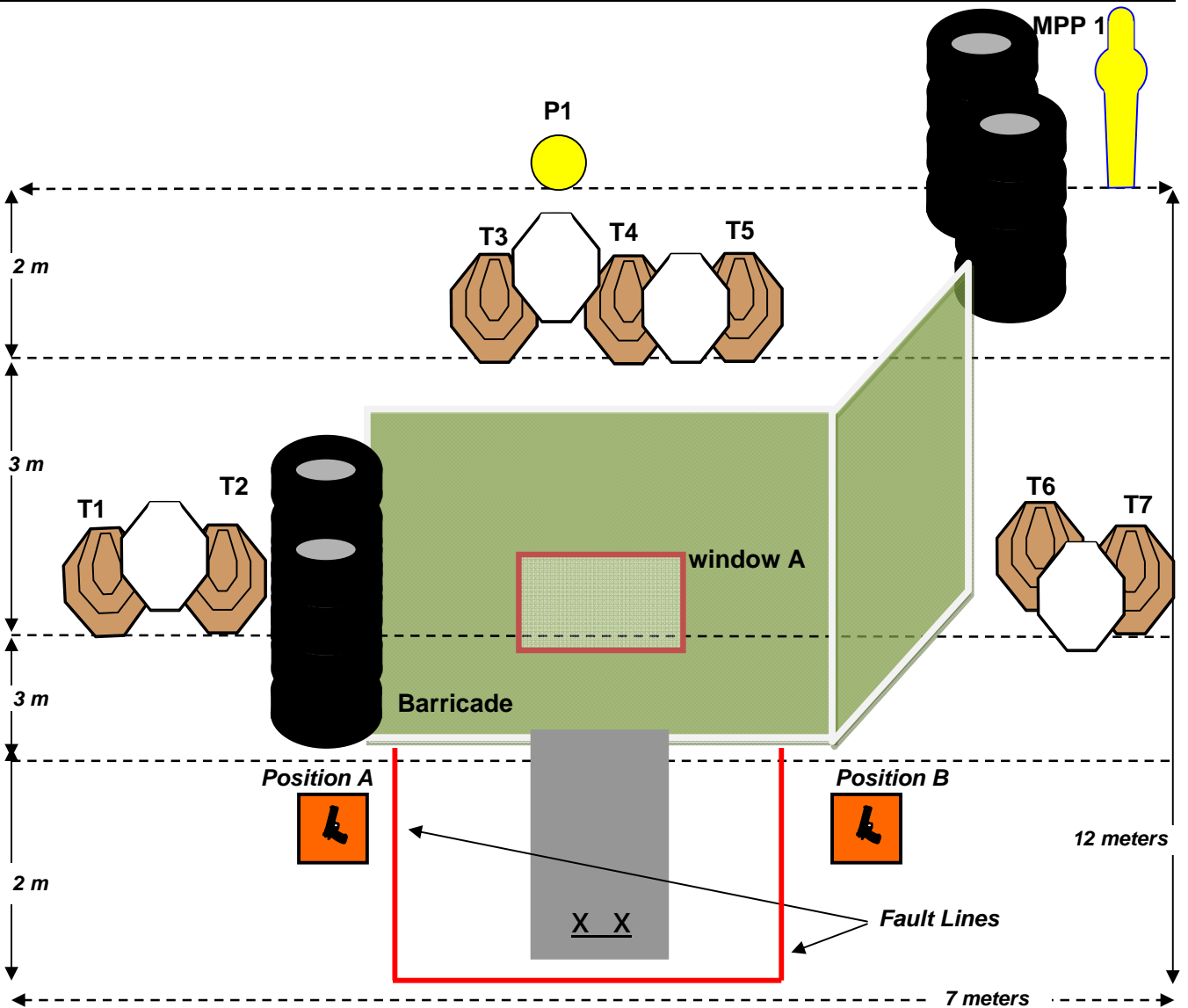

SETUP NOTES: Barricade window A with 0,50x0,50 meters and 0,50 meters of the soil. Mini Pepper Popper and Plate distances 8 meters.

RO NOTES:

Arbitration Fees 80,00 €





OPEN DE PORTUGAL 2010



RULES: Practical Shooting Handbook, Latest Edition

COURSE DESIGNER: R.O. José Gonçalves

START POSITION: Standing in the marks X X, facing down range, with knees in the soil and hands in the head.

START CONDITON: Handgun unloaded on the position A.

STAGE N.º 12 – (Medium Course)

STAGE PROCEDURE: Upon start signal, pick up the gun from position A and engage all targets in any order

SCORING: Comstock, 08 rounds, 40 points

TARGETS: 4 IPSC Targets.

SCORED HITS: Best 2 per paper. Metal down = 5 points

START-STOP: Audible signal - Last shot

PENALTIES: Per current edition IPSC Rule Book

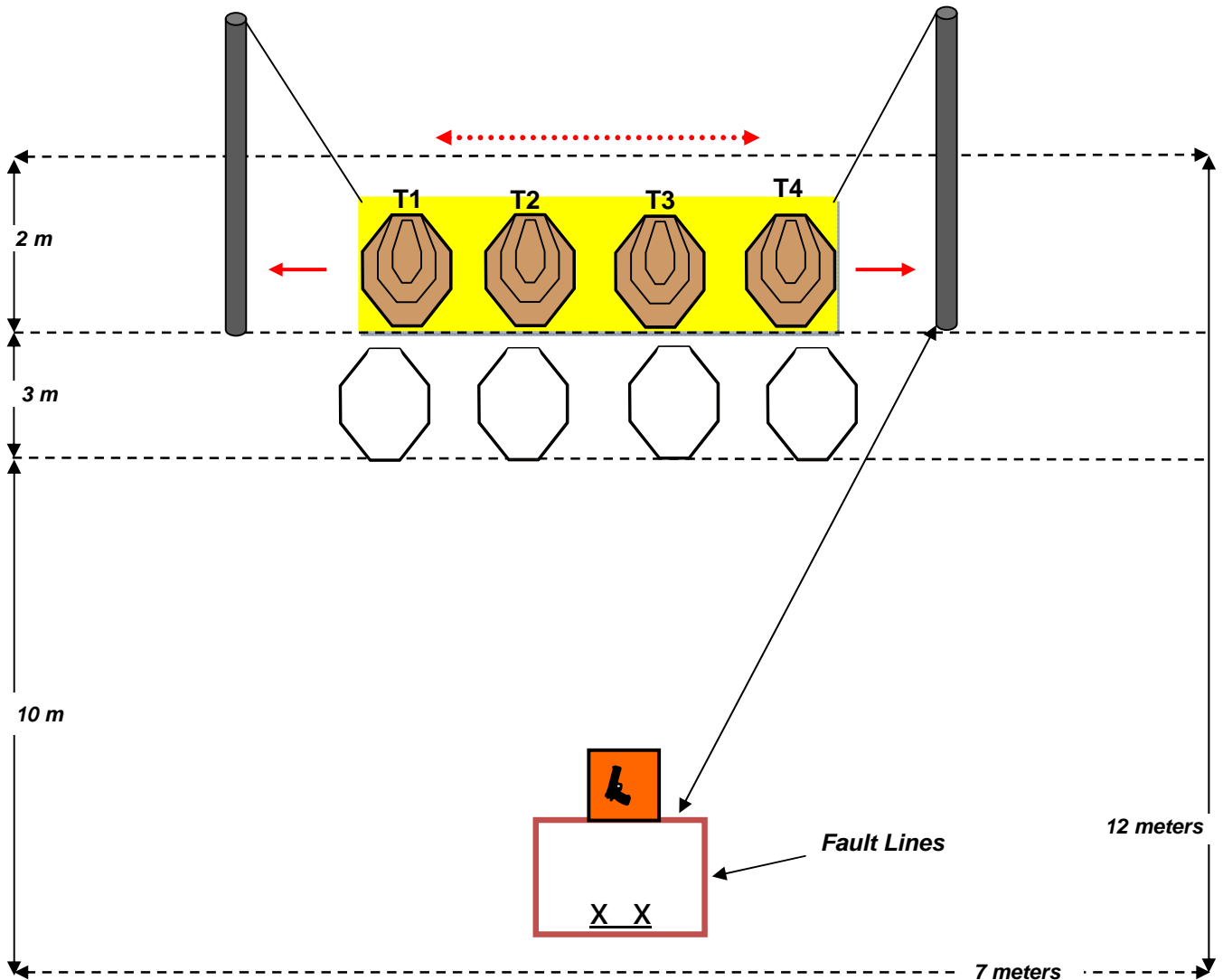

SETUP NOTES:

The swinger is activated by the shooter

RO NOTES:

Arbitration Fees 80,00 €

